

LONGER

## BT100-3J PERISTALTIC PUMP OPERATING MANUAL

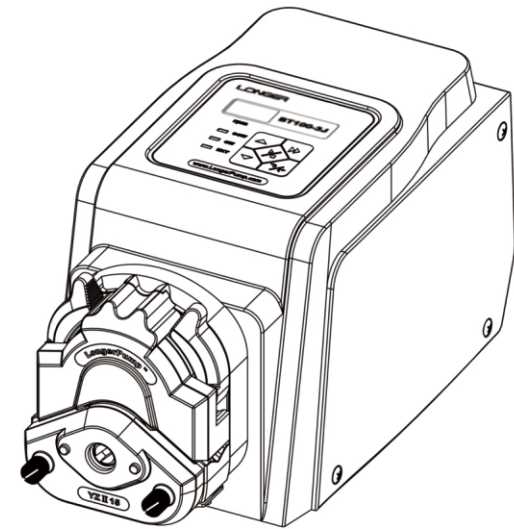

LONGER

**Baoding Longer Precision Pump Co., Ltd.**

Add: 3rd/4th Floor, Building 6B, University Science Park  
Baoding National, High - Tech Industrial Development Zone  
Baoding, Hebei, China 071051  
Tel: 86 - 312 - 3110087 3138553  
Fax: 86 - 312 - 3168553  
E - mail: [longer@longerpump.com](mailto:longer@longerpump.com)  
[Http://www.longerpump.com](http://www.longerpump.com)

BT100-3J Peristaltic Pump

Baoding Longer Precision Pump Co.,Ltd.

 **IMPORTANT INFORMATION :**

Please read operation manual carefully before operation.

 **WARNING :**

- Tubing breakage may result in fluid sprayed from pump. Use appropriate measures to protect operator and equipment. Please check the tubing frequently and changing the tubing in time.
- If the power line or the plug are worn or damaged please pull out the plug (Hold the plug not the power line when pulling out).
- Please shut down the power supply and pull out the plug when you think the pump needs to be maintained or repaired.
- Shut down the power supply of the pump when connecting to external control equipment.

**WARRANTY :**

The warranty period for this product is one year. If repair or adjustment is necessary within the warranty period, the problem will be corrected at no charge if it is not due to misuse or abuse on your part, as determined by the manufacturer. Repair costs outside the warranty period, or those resulting from product misuse or abuse, may be invoiced to you.

## **Table of Contents**

Introduction .....	1
Basic Operation .....	2
Start/Stop Key.....	2
Direction Key .....	2
Speed Increase/decrease Key .....	2
Prime Key .....	2
Acceptable Pump Heads and Tubing .....	3
Changing the Pump Head .....	4
External Control Function.....	4
Maintenance.....	6
Technical Specifications .....	7

**Introduction**

Acceptable pump heads for BT100-3J are YZ1515x, YZ2515x, YZII15, YZII25, DG,BZ,DG15 and DMD15-13. The pump delivers flow rates from 0.0002 to 380 mL/min. The speed can be adjusted manually or automatically through external control interface. Store the running parameter automatically. Easy to operate.

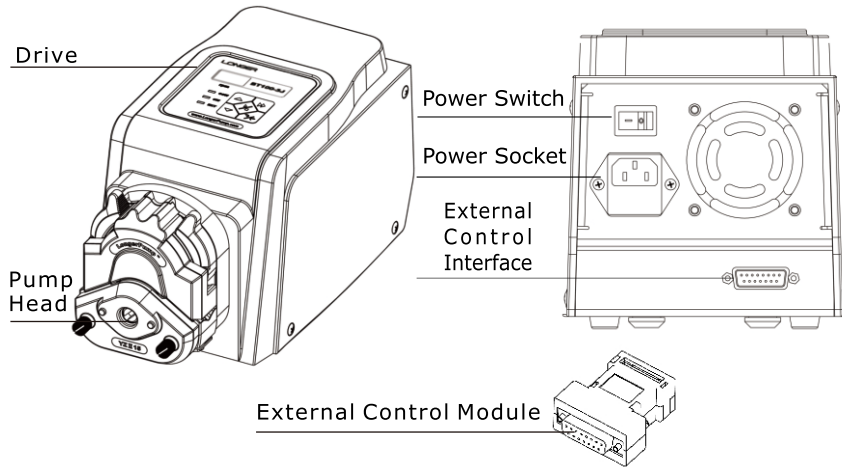

**Outside View**

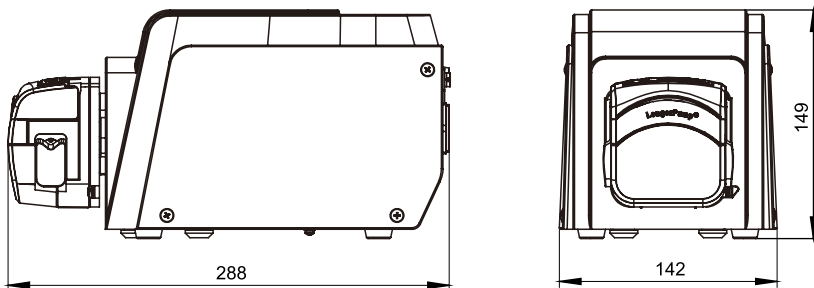

**Reference:**

- Make sure the power line of the pump is grounded reliably to protect the operator in humid condition.
- For detail information about external control function please see page 4.

**Basic Operation**

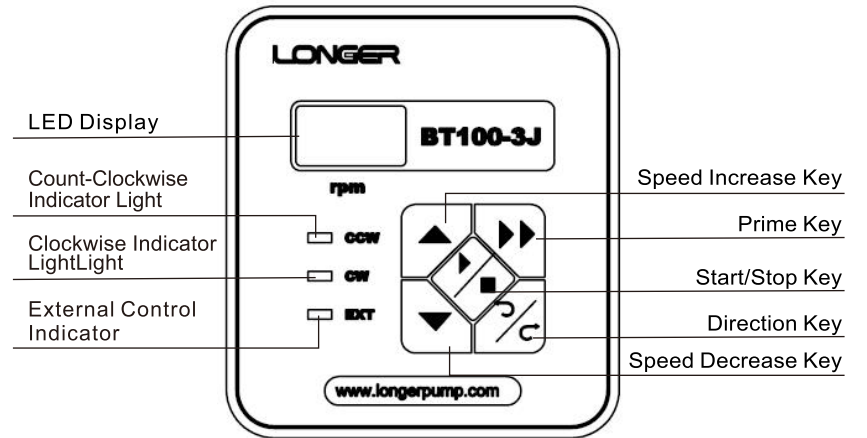

- **Start/Stop Key**  
Press the Start/Stop Key to start or stop the pump. This key is invalid in prime state when pump runs at full speed.
- **Direction Key**  
Press the Direction Key to change the rotating direction of the pump and the corresponding Clockwise Indicator Light is lit or the corresponding Counter-Clockwise Indicator light is lit. The Direction Key is invalid in prime state.
- **Speed Increase/decrease Key**  
Press the Speed Increase Key or Decrease Key one time to increase or decrease the speed in step of 0.1 rpm. Continuously press the increase key or decrease key to change the speed rapidly. The Speed Increase Key and Decrease Key are invalid in prime state.
- **Prime Key**  
In common state, press the Prime Key to enter prime state when the pump runs at full speed (that is 100 rpm) and the LED displays "---" for emptying, filling and rinsing operation; Press the Prime Key again to return to common state.

**Acceptable Pump Heads and Tubing**

Pump Head	Tubing	Tubing material	Max.Flow Rate (ml/min)
YZ1515x-A YZ1515x-C YZII15	13#, 14#, 19#, 16#, 25#, 17#, 18#	Silicone/Pharmed	380
YZ1515x-B YZ1515x-D	13#, 14#, 19#, 16#, 25#, 17#, 18#	Silicone/Pharmed	240
YZ2515x-A YZ2515x-C YZII25	15#, 24#	Silicone	270
BZ15-13-A BZ15-13-B BZ15-13-C BZ15-13-D	14#, 16#, 25#, 17#	Silicone	300
BZ25-13-B	24#	Silicone	300
DMD15-13-B DMD15-13-D	2×13#, 2×14#, 2×19#, 2×16#, 2×25#	Silicone	350
DG-1(C/E/G) DG-2(C/E/G) DG-4(C/E/G)	ID≤3.17mm, Wall Thickness 0.8-1mm	Silicone/Pharmed	48
DG-1(D/F/H) DG-2(D/F/H) DG-4(D/F/H)	ID≤3.17mm, Wall Thickness 0.8-1mm	Silicone/Pharmed	32
DG15-24	16#, 25#, 17#	Silicone	300
DG15-28	ID≤3.17mm, Wall Thickness 0.8-1mm	Silicone	75
	13#, 14#	Silicone	75

**Changing the Pump Head**

The pump head has been installed on drive before leaving the factory. Please follow below procedure when changing a new pump head is needed.

1. Loose the tightening screws which connecting the pump head and the drive. Take down the pump head.
2. Insert the flat end of the new pump head's shaft to the slot of the drive's coupling. Make the positioning hole of the pump head match the positioning pin of the drive.
3. Tighten the screws which connecting the pump head and the drive. Try your best to tighten the screws in the same degree. Do not over-tighten the screws to prevent the housing from deforming. (Please reference the pump head operating manual for details.)

 Shut down the power supply before changing a new pump head.

**❖ Check the Pump Head Occlusion**

Load the tubing in pump head and insert one side of tubing in water and blow to the other side. There should be no air bubble in water. If there is air bubble in water, that's because the wall thickness of the tubing is too thin to be used in this pump head.

**External Control Function**

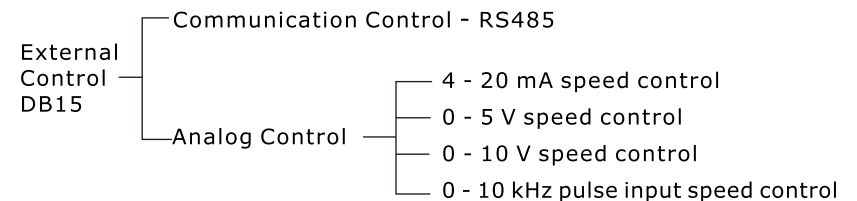

**❖ Communication Control**

Please contact Longer Company for communication protocol.

❖ Analog Control

- Show as below for external control module. If you need external control function you just insert the external control module to the external control interface which is on the rear panel of the pump. Connect the corresponding control signal wire.

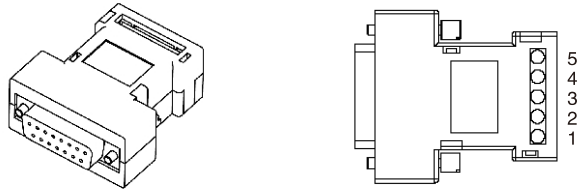

External Control Model

💡 Four kinds of standard external control module need to be ordered separately according to special requirements.

❖ Terminal Definition of Standard External Control Module

- 1# is analog input in 4 - 20 mA, 0 - 5 V, 0 - 10 V external control modules. Control the speed of the pump.
- 2# is external control start/stop input. When connected to COM, the pump runs; When connected to high level (5 - 10 V), the pump stops.
- 3# is external control cw/ccw input. When connected to COM, the pump rotates clockwise; When connected to high level, the pump rotates counter clockwise.
- 4# is analog ground (AGND) in 4 - 20 mA, 0 - 5 V, 0 - 10 V external control modules; 4# is pulse input in pulse input external control modules. Control the speed of the pump. 10 KHz is corresponding to the max.speed.
- 5# is the COM of external control direction and start/stop signal input; It's also the COM of pulse signal input in pulse input external control module.

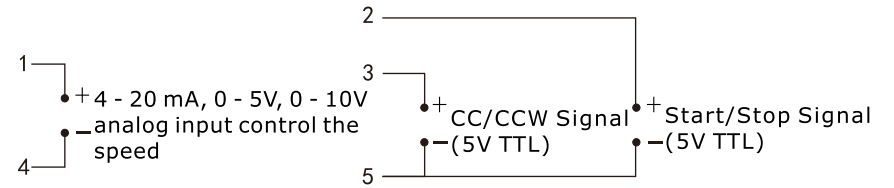

0 - 5V, 0 - 10V, 4 - 20mA  
External Control Input Module Connection Diagram

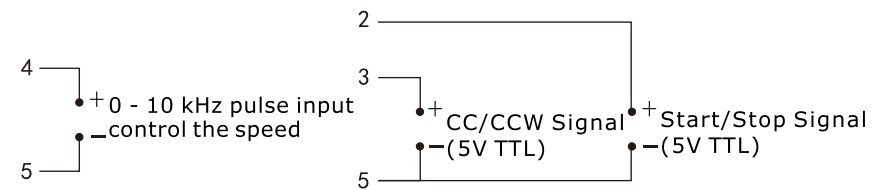

0 - 10 kHz Pulse Signal Input Connection Diagram

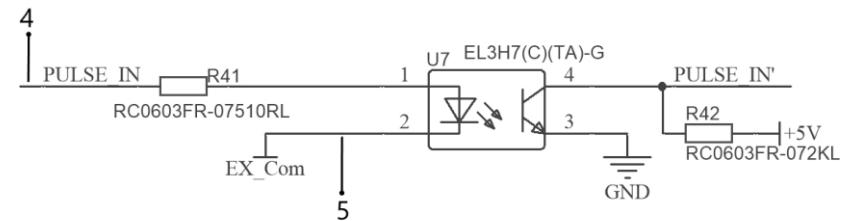

Circuit Diagram of External Control Interface for Pulse Signal

**Maintenance**

- When the pump is idle, we recommend you to release the tubing from pressure. This helps to protect the tubing from unnecessary strain and prolongs its service life
- Keep rollers clean and dry. This will prolong the service lives of tubing and pump head.
- The surface of drive and the pump head are not organic solvent and aggressive liquids resistant. Please pay attention when using.

💡 If a trouble happens, please contact us or our dealers.

## Technical Specifications

### ❖ Functions

Acceptable Pump Heads	YZ1515x, YZ2515x, YZ II15, YZ II25, BZ, DG, DG15, DMD15-13
External Control	Start/stop, cw/ccw control and speed control (0-5V, 0-10V, 4-20mA and 0-10kHz optional)
Prime	Fast filling and emptying
Speed Control	The speed can be adjusted manually or automatically through external control interface
Display	Display current rpm, direction and running status
Direction Control	CW and CCW reversible
Communication Function	RS485
Memory Function	Storing the running parameter automatically (the running status must stay at least 5 seconds)

### ❖ Specifications

Speed	0.1-100 (rpm)
Speed Precision	0.1rpm
Speed Adjusting	Membrane keypad continuous adjusting
Display Mode	3 digital LED displays current rpm
Applicable Power	AC 100~240V 50/60Hz
Power Consumption	≤20W
Operating Condition	Temperature 0°C~40°C Relative humidity <80%
Drive Dimensions	232×142×149(mm)
Drive Weight	2.38kg
IP Rating	IP20